





SCHEMA BELT

design meneghello paoelli
associati



Il tubo flessibile, parte del circuito idraulico, viene portato in vista e trasformato in un'elegante "cintura" porta salviette. Un oggetto tecnico solitamente nascosto diventa così un accessorio di moda e un complemento d'arredo, assumendo una nuova valenza che completa la funzionalità del prodotto.

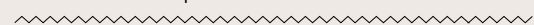

The flexible hose, part of the hydraulic circuit, is brought to view and transformed into an elegant towel-holder "belt". A technical object usually hidden thus becoming a fashion accessory and a piece of furniture, taking on a whole new meaning completing the product functionality of the product.







reddot award 2014
winner



*Finiture fotografate in queste pagine: Marron
d'Inde SW208F e "belt" in pelle naturale*

*Finishes photographed on these pages: Marron
d'Inde SW208F and "belt" in natural leather*

SCHEMA BELT

hxb (cm)	n numero elementi/ elements number	peso a vuoto / weight empty (kg)	volume d'acqua / water volume (dm ³)	a (cm)	c (cm)	d (cm)	e (cm)	Qs resa termica / thermal yield □t 50°C (watt)	Q potenza elettrica / electrical power (watt)	versione mista**** / combined version****	fissa / not opening	apribile / opening
												
verticale/vertical												
120,0x49,0	1	16,6	0,66	33,0	54,0	-	-	515	500	•	•	•
150,0x49,0	1	20,6	0,82	33,0	84,0	-	-	652	600	•	•	•
180,0x49,0	1	25,5	0,99	33,0	114,0	-	-	795	800	•	•	•

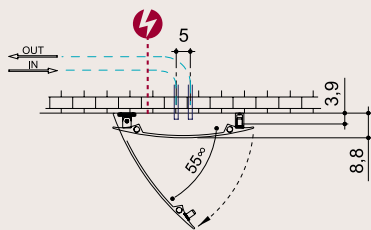
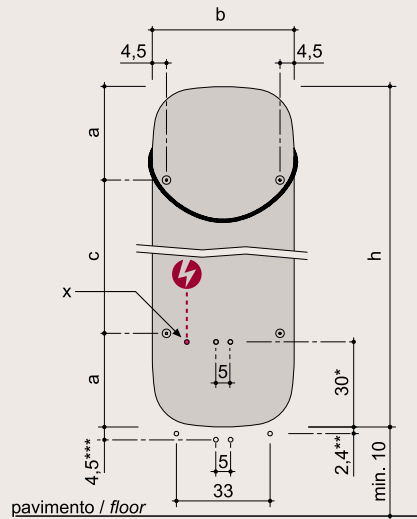

versione apribile
opening version

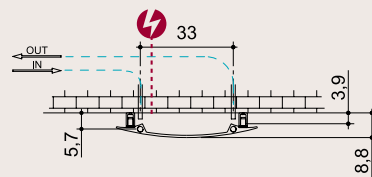

versione fissa
not opening version

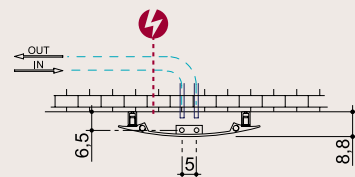

versione fissa con sovrapprezzo
not opening version with surcharge

- *.
- per versione apribile
- **.
- per versione fissa standard
utilizzando valvole Ridea
- ***.
- per versione fissa con
sovrapprezzo utilizzando
valvole Ridea
- ****.
- a richiesta con sovrapprezzo
solo per versione apribile
- X.
- posizione ingresso a muro del
cavo (per versione elettrica
e mista)
- ~~~~~
- *.
- for opening version
- **.
- for not opening standard
version using Ridea valves
- ***.
- for not opening version with
surcharge using Ridea valves
- ****.
- upon request with surcharge for
opening version only
- X.
- Electrical wire wall entry
position (for electric and
mixed version)